



Base



Bend



Tee

STRUCTURE AND SUPPORTS



STRUCTURE AND SUPPORTS

SUPPORT OF COLUMN

Glass plants and pipeline should be supported correctly. To prevent inducing undesirable stresses in the glass, supports should be rigid. When supported, glass should be in compression.

Generally, glass plant and equipment are supported in a rectangular tubular structure. This structure is formed of galvanized mild steel tubing with the cast iron fittings which are described in this catalogue. This type of structure provides enough flexibility for future modifications and is strong enough to support a glass unit.

Following rules should be followed while supporting a glass unit in a tubular structure.

1. The structure must be rigid. To give lateral support it must be braced back to the nearest wall or any rigid feature.
2. All glass columns are built up from a fixed point on which whole weight of the column should be taken. If total load exceeds the permissible limits, counter balance supports should be used to relieve excessive weight.
3. With change in temperature, glass column and tubular structure expands at different rate. Therefore glass unit must be free for vertical movement above the fixed point. Hence, above the fixed point, guides supports should be used to give lateral support.

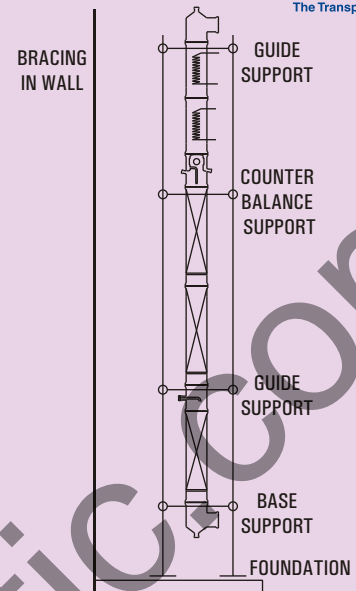

STRUCTURE TUBES, GALVANISED

For forming the structure, "B" class galvanised tubes, Mild Steel with Epoxy Coated, Stainless Steel 304 & 316 are used in size of 1/2", 1", 1.1/4", 1.1/2" and 2". Cut tubes are available in required length to form a standard size structure. Cut tubes are provided with rubber plug at both the ends.

Tube size

NB Inches	NB mm	External Diameter
1/2"	15	19.5
1"	25	32.5
1.1/4"	30	41.5
1.1/2"	40	48.3
2"	50	60.3

Available cut lengths

Structure Dimension	NB (mm)				
	15*	25*	30*	40*	50*
2500	-	2500	-	-	-
3000	-	3000	3000	-	-
3500	-	3500	3500	-	-
4000	-	-	4000	-	-
6000	-	6000	6000	6000	6000

For Vertical installation

2500	-	2500	-	-	-
3000	-	3000	3000	-	-
3500	-	3500	3500	-	-
4000	-	-	4000	-	-
6000	-	6000	6000	6000	6000

For Frames

400	-	365	355	345	335
500	-	465	455	445	435
600	-	565	555	545	535
800	-	765	755	745	735
1000	-	965	955	945	935
1200	-	1165	1155	1145	1135
1500	-	1465	1455	1445	1435

For Frames

400	435	445	445	455	465
500	535	545	545	555	565
600	635	645	645	655	665
800	835	845	845	855	865
1000	1035	1045	1045	1055	1065
1200	1235	1245	1245	1255	1265
1500	1535	1545	1545	1555	1565

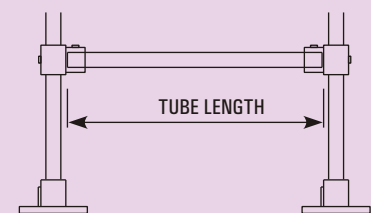

STRUCTURE DIMENSION

Cat. Ref. TBG (NBmm/Cut length)
for e.g. TBG 25/365

STRUCTURE AND SUPPORTS

STRUCTURE FITTINGS

Following structure fittings are available to use with galvanised tubes in order to form a tubular structure for a glass plant. These fittings are made of cast iron. Also available in Stainless Steel 304 & 316 and are suitable to the galvanised tubes described earlier.

These slidable fittings are provided with grub screws to fix it at required position on a galvanised tube.

These fittings are specially made to construct a tubular structure which provides enough flexibility for future modifications without involving any hammering and welding.

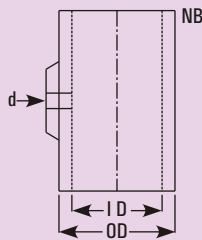

STRUCTURE FITTINGS - GENERAL DATA

NB	TUBE DIA	ID	OD	d
25	32.5	35	45	1/2"
30	42.5	45	55	1/2"
40	48.3	51	61	1/2"
50	60.3	63	73	1/2"

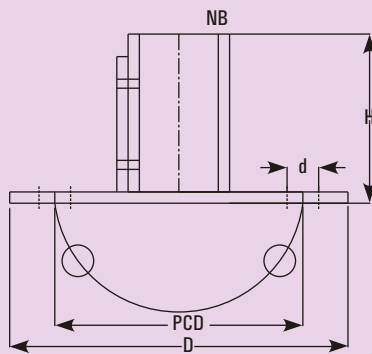

STRUCTURE FITTINGS - BASE

These are to be used with vertical tubes. Holes are provided for foundation.

Cat.Ref.	NB	D	H	PCD	d ϕ
BS25*	25	150	75	110	4 x 14 ϕ
BS30*	30	150	75	110	4 x 14 ϕ
BS40	40	150	75	110	4 x 14 ϕ
BS50	50	175	75	125	4 x 14 ϕ

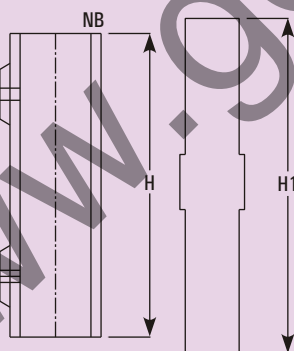

STRUCTURE FITTINGS - COUPLER

These are generally used to couple the vertical tubes where more length is require.

Cat.Ref.	NB	H	H1
CL25	25	150	200
CL30	30	150	200
CL40	40	150	200
CL50	50	150	200

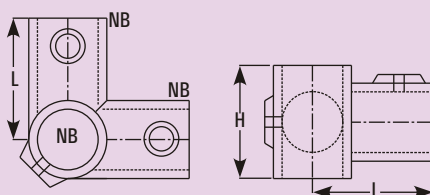

STRUCTURE FITTINGS - BEND

These are used to build frames on vertical tubes.

Cat.Ref.	NB	H	L
BN 25*	25	50	55
BN30*	30	65	70
BN40	40	70	80
BN50	50	85	95

* marked items are available fast.

STRUCTURE AND SUPPORTS

STRUCTURE FITTINGS -

TEE

Cat.Ref.	NB	H	L
T25*	25	50	55
T30*	30	65	70
T40	40	70	80
T50	50	85	95

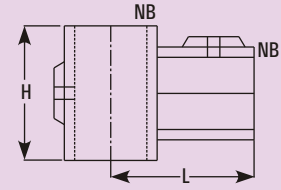

STRUCTURE FITTINGS -

DOUBLE BEND

Cat.Ref.	NB	H	L
BN 25	25	50	55
BN30	30	65	70
BN40	40	70	80
BN50	50	85	95

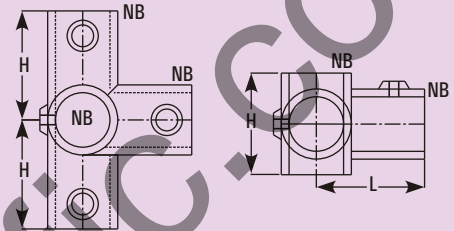

STRUCTURE FITTINGS -

DOUBLE TEE

Cat.Ref.	NB	H	L
DT25	25	50	55
DT30	30	65	70
DT40	40	70	80
DT50	50	85	95

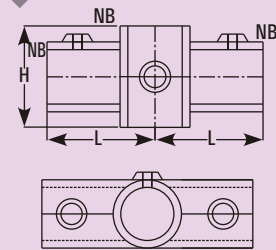

STRUCTURE FITTINGS -

EQUAL BRACKET

Cat.Ref.	NB	H	L	L1
EBT25*	25	40	65	50
EBT30*	30	52	75	60
EBT40	40	62	85	60
EBT50	50	72	95	60

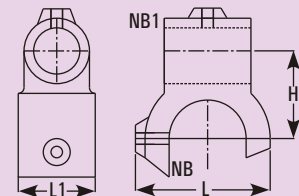

STRUCTURE FITTINGS -

UNEQUAL BRACKET

Cat.Ref.	NB	NB1	H	L	L1
UBT25/15*	25	15	35	65	50
UBT30/15*	30	15	40	75	60
UBT40/25	40	25	50	85	60
UBT50/25	50	25	55	95	60

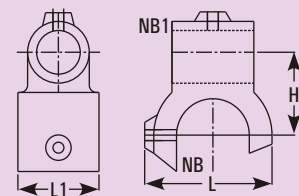

STRUCTURE FITTINGS -

CROSS

Cat.Ref.	NB	H	L
X25	25	50	45
X30	30	65	55
X40	40	65	70
X50	50	65	85

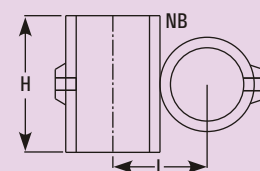

STRUCTURE AND SUPPORTS

STRUCTURE FITTINGS - SUPPORT

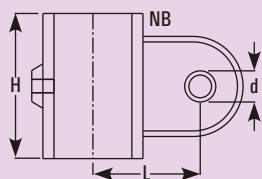

Cat.Ref.	NB	h	L	d
SPT15*	15	40	35	13
SPT25*	25	55	50	13
SPT30*	30	55	57	13
SPT40	40	55	62	13
SPT50	50	55	67	13

STRUCTURE FITTINGS - PLUGS

These are used to plug the open ends of galvanised tubes.

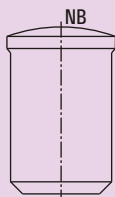

Cat. Ref.	NB
PLUG15	15
PLUG25	25
PLUG30	30
PLUG40	40
PLUG59	50

STRUCTURE FITTINGS - STUDS

These are used as screwed rods with supports

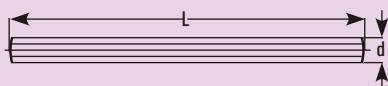

Cat.Ref.	d	L
STUD5/16-150	5/16"	150
STUD3/8-150	3/8"	150
STUD1/2-200	1/2"	200

STRUCTURE DIMENSIONS FOR COLUMNS

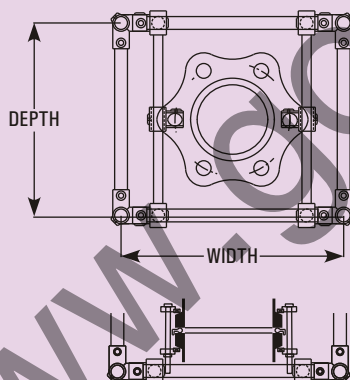

DN	Recommended tube size NB (mm)	Minimum Structure size Depth X Width
80	25	500 x 500
100	25	500 x 500
150	25,30	600 x 600
225	30	800 x 800
300	30	800 x 800
400	30	1000 x 1000
450	30,40	1000 x 1000
600	40,50	1200 x 1200

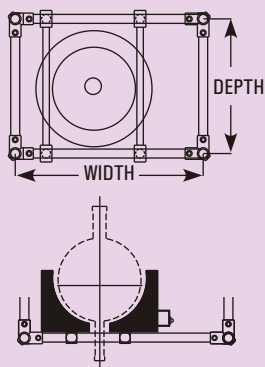

FOR VESSELS (IN HEATING MENTLES)

Size (Litres)	Recommended tube size NB (mm)	Minimum Structure size Depth X Width
20	25	400 x 600
50	25	600 x 800
100	25,30	800 x 800
200	30	800 x 1000

* marked items are available fast.

STRUCTURE AND SUPPORTS

FOR VESSELS (IN HEATING BATHS)

Size (Litres)	Size NB (mm)	Recommended tube size Depth X Width	Minimum Structure size
20		25	500 x 600
50		25	600 x 800
100		25,30	800 x 1000
200		30	800 x 1200

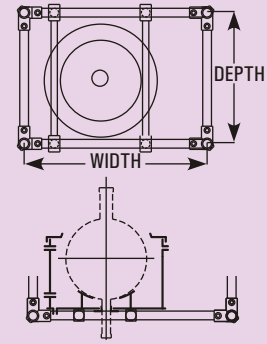

FOR VESSELS (IN VESSEL HOLDERS)

Size (Litres)	Recommended tube size NB (mm)	Minimum Structure size Depth X Width
20	25	500 x 600
50	25	600 x 800
100	25,30	1000 x 1000
200	30	1000 x 1000

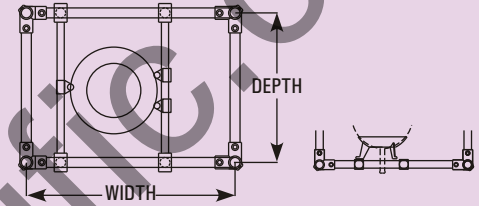

COLUMN BASE SUPPORT FRAMES

These channel frames are used as fixed support in erection of columns. These are supplied with full threaded jacking rods and U bolts.

Cat.Ref.	PCD	L1	L	H
FCSH225	310	1000	800	75
FCSH300	395	1000	800	75
FCSH400	495	1200	1000	75
FCSH450	585	1200	1000	100
FCSH600	710	1400	1200	100

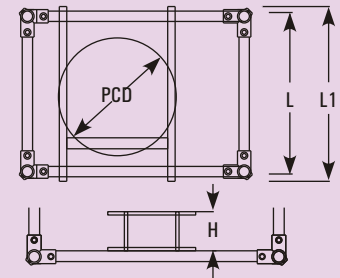

STRUCTURE AND SUPPORTS

GRROUTING OF BASE

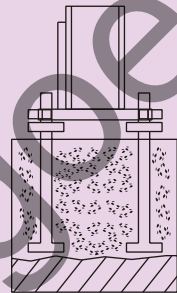
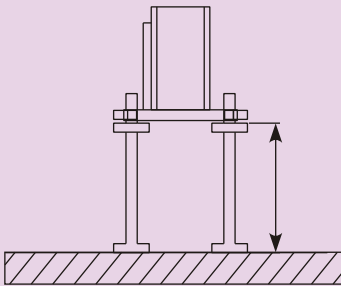
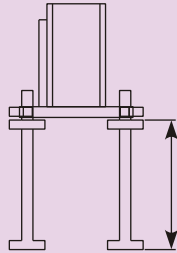
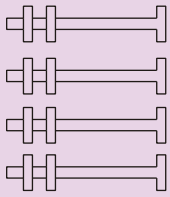
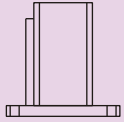

1.
Take one Cast Iron BASE
and four foundation Bolts,
each with 2 nuts.

2.
Fit the bolts in BASE so
that base is raised upto
150mm from head of bolts.

3.
Put this assembly on the
floor and prepare a rough
surface for proper bonding
of grouting.

4.
Make a concrete block
over the bolts of about
200 x 200 mm upto the
base of BASE i.e. 150mm
high.

5.
Prepare separate block
for each BASE instead of
making one big common
block. For all BASES.

* marked items are available fast.

ASSEMBLING OF STRUCTURE

1. Mark the position of required fittings on all the Vertical tubes, slide them in correct sequence and lightly Tighten.
2. Assemble one side frame of the structure by adding the cross tubes between two vertical tubes.
3. Assemble other side frame of the structure by adding the cross tubes between other two vertical tubes.
4. Build up the cross tubes in one side frame and Tighten lightly.
5. Add the other side frame on it and tighten all the fittings firmly.
6. Hoist the structure and brace it to some existing rigid feature.
7. Grout the foundation bolts and fix the structure bases with that.
8. Adjust bracing to obtain a correct plumb in Structure.
9. Adjust the horizontal frames in correct level.
10. Assemble the support tubes at their positions.

